

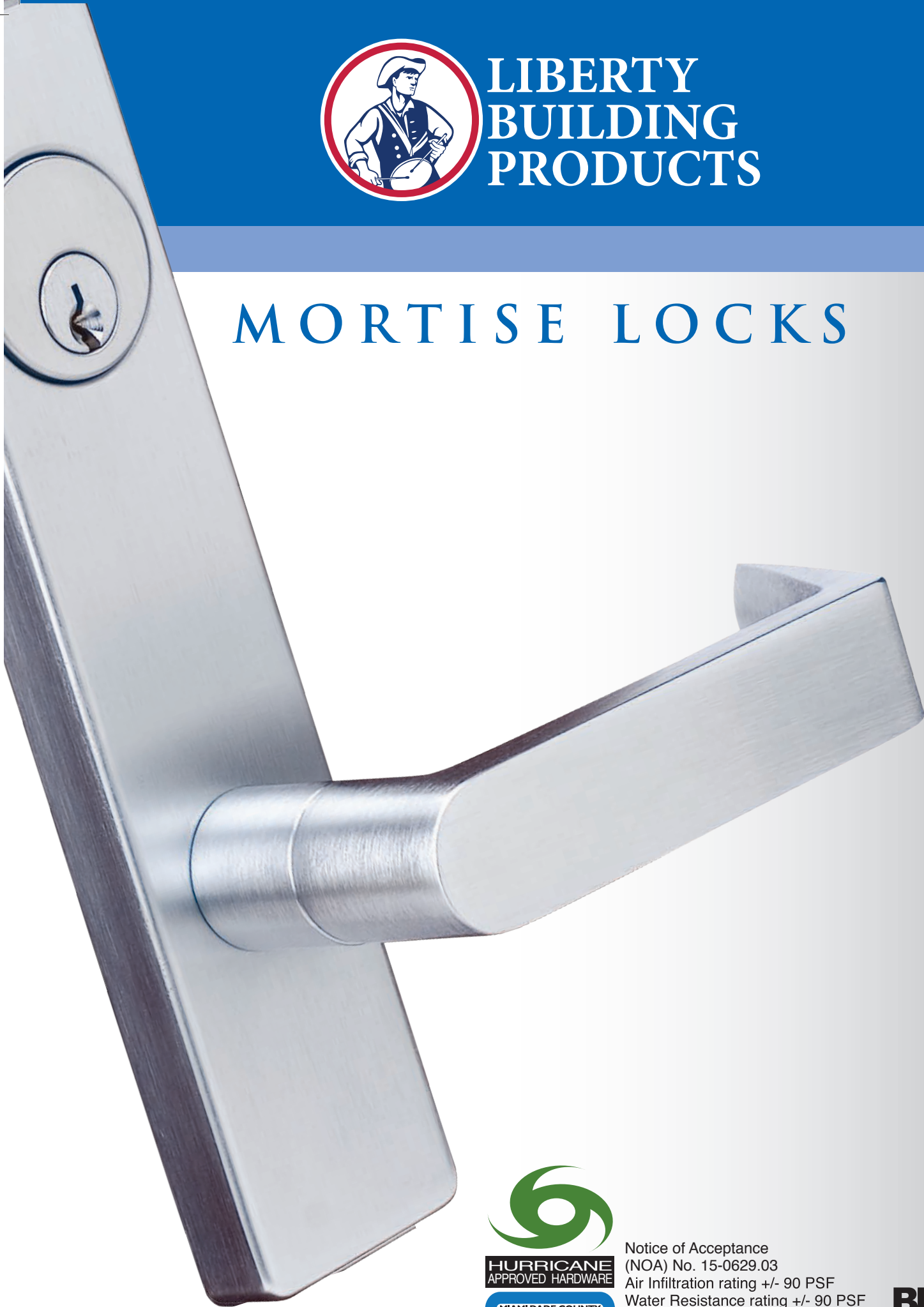

**LIBERTY
BUILDING
PRODUCTS**

MORTISE LOCKS



**HURRICANE
APPROVED HARDWARE**

**MIAMI-DADE COUNTY
APPROVED**

Notice of Acceptance
(NOA) No. 15-0629.03
Air Infiltration rating +/- 90 PSF
Water Resistance rating +/- 90 PSF
Florida Building Code: 20485

**BHMA
CERTIFIED™**

lock design



LIFETIME Warranty

BHMA
CERTIFIED

GRADE 1



certification / compliance

- Locks comply with UL 10B, "Fire Tests of Door Assemblies, and "UL 10C," "Positive Pressure Fire Tests of Door Assemblies" and the Uni form Building Code Standard UBC 7-2, "Fire Test of Door Assemblies" (1997).
- BHMA certified, Meets ANSI/BHMA A156.13-2005, Series 1000, Grade 1.
- Lever design complies with California State Reference Code: levers return to within 1/2" (13mm) of door face.
- Comply with ANSI A117.1 for Barrier Free Accessibility.
- **Hurricane Approved Hardware rated +/- 90 PSF by Miami-Dade County NOA #15-0629.03 Florida Building Code: 20485**



deliberate design



- Eescutcheon Lever and Sectional Lever Type available.
- Outside trims are concealed screw to prevent vandalism.
- Featured heavy-duty spring cartridge on both exterior and interior to prevents lever sag.
- Posts fit through holes in the lock case and are secured by square spindle.
- 3 Lever designs are available as shown above.

easy for handing

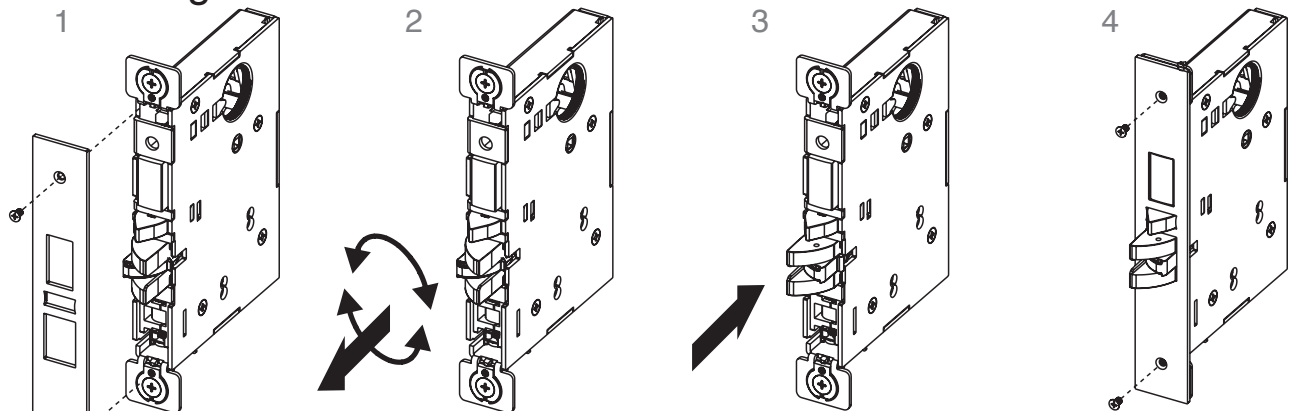

1. Remove the armor front.

2. Pull out the latch bolt and rotate it 180° clockwise or counterclockwise.

3. After ensuring it's position, push the latch bolt back into the latch to complete the handing changing.

4. Put back and fasten the armor front with screws.

lock design

LIFETIME Warranty

features

door thickness

- 1-3/4" to 2" standard, 2-1/4" special order

spacing

- Center to center, hub to cylinder: 3-7/8" (98mm)
- Center to center, hub to turnpiece 2-11/16" (68 mm)

handing

- Field reversible (Standard shipped in Right hand)

mortise case

- Size – 6-1/32" x 4-1/32" x 57/64"
- Heavy Gauge cold rolled steel, zinc dichromate plated for corrosion resistance
- Faceplate Adjustable from flat to standard 1/8" in 2" beveled door edges

backset

- 2-3/4" only

faceplate

- 8" x 1-1/4". Stainless steel

latchbolt

- 3/4" throw anti-friction, stainless steel. Field reversible

deadbolt (on applicable functions)

- 1" throw, stainless steel

guard bolt (on applicable functions)

- Non-handed, stainless steel

toggle (on applicable functions):

- Rocker Type, stainless steel

strike

- 4-7/8" x 1-1/4" x 3/32" (ASA) Curved Lip, Stainless steel

mortise cylinder

- 6-pins Schlage keyway with 2 keys
- Schlage L Cam
- Size 1-1/4" Standard for Escutcheon Trim, door fitting 1-3/4"
- Size 1-1/8" Standard for Sectional Trim, door fitting 1-3/4"

keying

- Can be MK, CMK, GMK

finish

- 626 (US26D), 613 (US10B), Special order for 630 (US32D)

outside trim

- Standard commercial style lever, forged Brass
- Trim available in both Escutcheon Plate (ME) and Sectional Rosette (MS) format, forged Brass
- Concealed screws on Sectional Trim

720ME-SD
San Diego (SD) Lever



720MS-BN
Bozeman (BN) Lever



lock design



LIFETIME Warranty

new case

Distance from cylinder hole center line to lever hub center line is 3-7/8" (98mm)

armor front

- 8" x 1-1/4" Outside front plate, stainless steel
- Adjustable for door bevels from flat to 1/8" in 2" deadbolt

- 1" throw, stainless steel with heavy gauge hardened steel insert

latchbolt

- 3/4" throw, 3 piece stainless steel antifriction latch bolt, reversible for right hand or left hand door

auxiliary deadlatch

- Non-handed stainless steel

ul listed

- For application on labeled fire doors

backset

- 2-3/4" only

case

- Wrought steel, zinc dichromated

toggle

- Rocker type, stainless steel

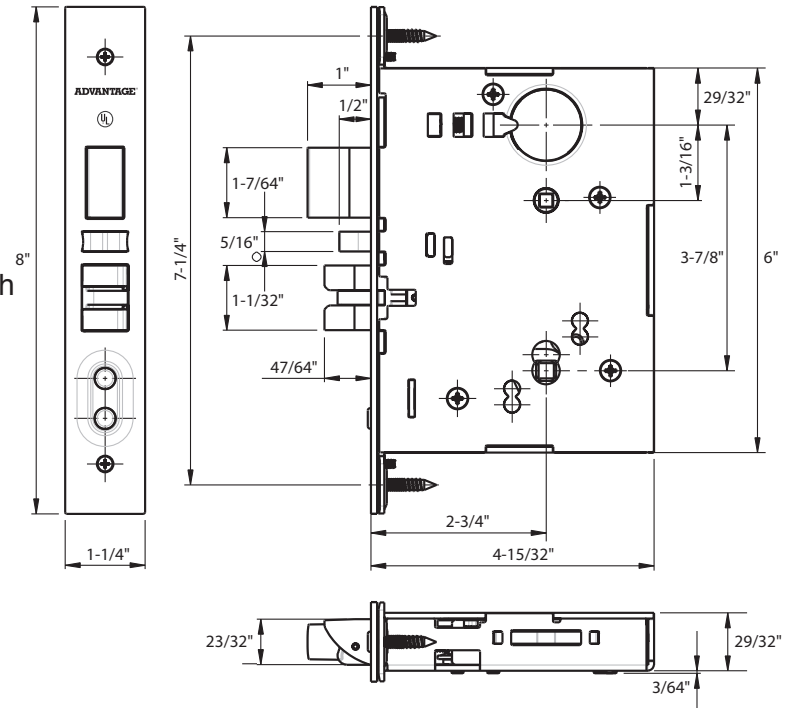

mortise cylinder and door fitting application:

Fitting Door Thickness	Mortise Lock	Mortise Cylinder - Cylinder Collar Fitting		
		1-1/4"	1-3/8"	1-9/16"
1-3/4"	ME Single	OK	OK	CR2-3
	ME Double	OK	CR2-3	CR2-4
2"	ME Single	OK	OK	OK
	ME Double	OK	OK	CR2-3
1-3/4"	MS Single	OK	C13	C16
	MS Double	OK	C16	C20
2"	MS Single	OK	C13	C16
	MS Double	OK	C16	C20

• 2-1/4" Door Thick – Please call to check (Lock body should use longer screw post x 2 when door thickness is 2-1/4")

Mortise Cylinder Length

1-1/4" (31.7mm) – Available with KW1, SC4, BEST SFIC 6pins Housing

1-3/8" (34.9mm) – Available with KW1, SC4, BEST SFIC 7pins Housing

1-9/16" (39.6mm) – Available with Schlage FSIC Housing

* All Mortise Cylinder are equipped with Schlage style L cam

Cylinder Collar Sizes

For ME: CR2 (2 side reversible)

Front: CR2-3 Side for 1/8" (3mm) extended height

Back: CR2-4 Side for 5/32" (3.8mm) extended height



For MS: C10 – 25/64" (10.0mm) Standard

C13 – 1/2" (13.0mm)

C16 – 5/8" (16.2mm)

C20 – 13/16" (20.5mm)



Mortise Cylinder



CAM STYLE:
SL-Schlage

BEST SFIC Mortise Housing



SLC-Schlage L
BEST IC

Schlage FSIC Mortise Housing



SL1-Schlage L
Schlage IC

dimensions

LIFETIME Warranty

ME - escutcheon trim lever style

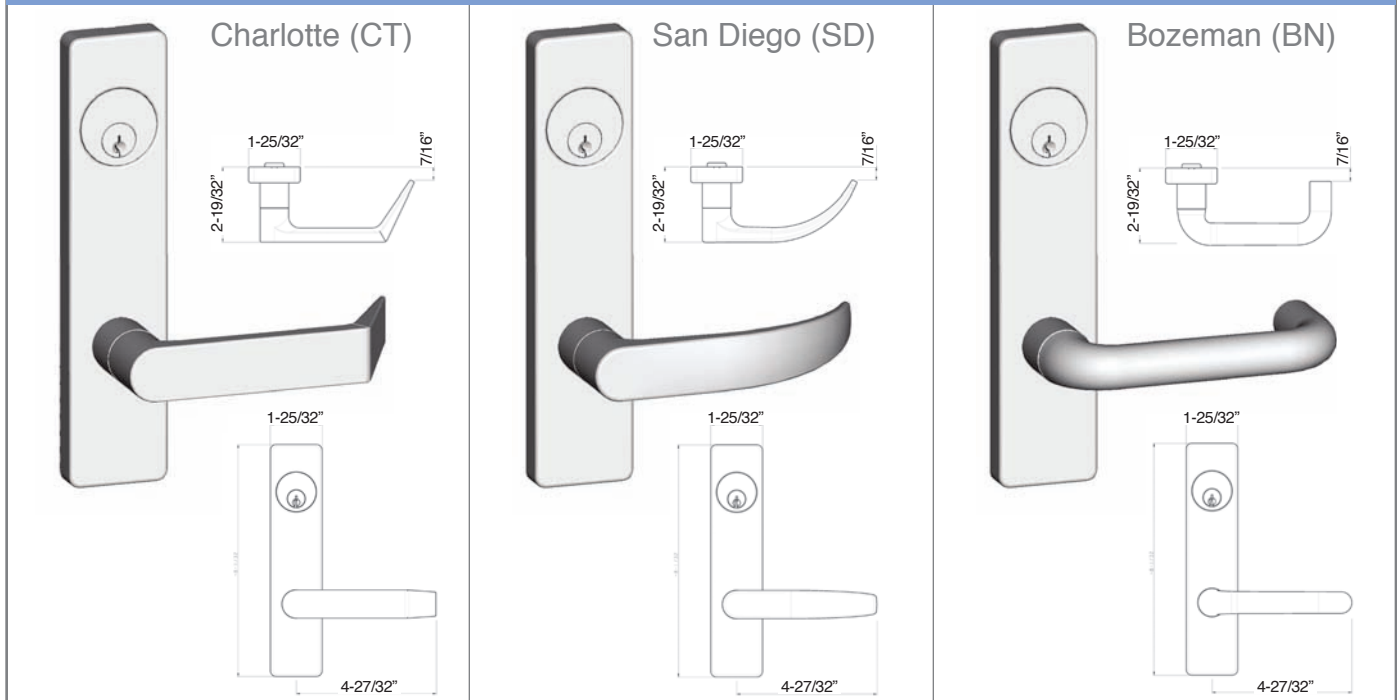

MS - sectional trim lever style

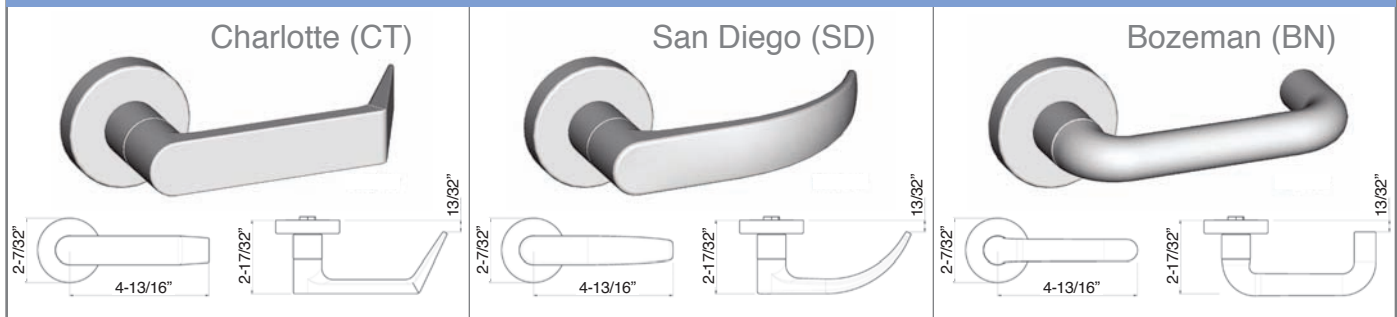

Special order lever/knob

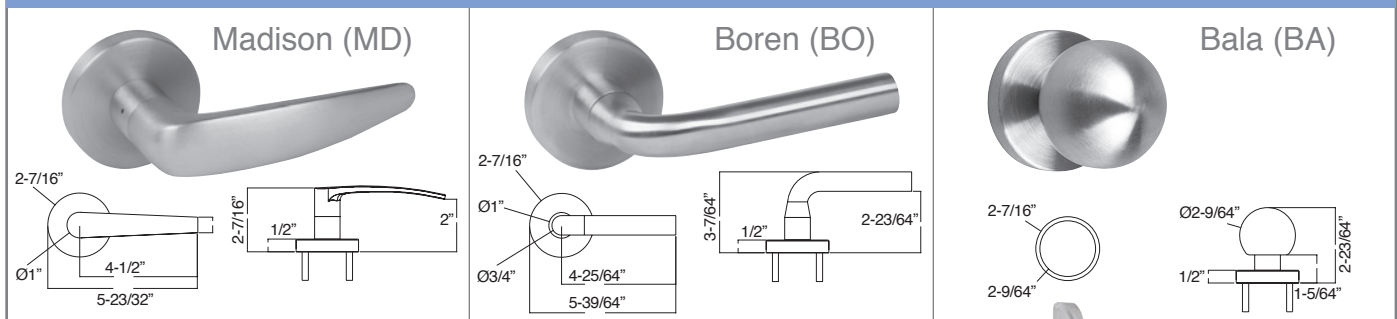

Exterior Indicator
for Privacy (F02, F19, F22)



Interior
ADA Thumbpiece

single cylinder without deadbolt

704M Office/Entrance (w/toggle) ANSI F04

- Latch bolt operated by lever from either side except when outside lever is made inoperative by the toggle.
- When outside lever is locked, latch bolt is retracted by key from outside or by operating inside lever.
- Auxiliary dead latch.

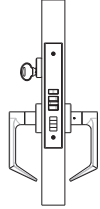

705M Classroom ANSI F05

- Latch bolt operated by lever from either side except when outside lever is locked from outside by key.
- When outside lever is locked, latch bolt is retracted by key or by operating inside lever.
- Auxiliary dead latch.

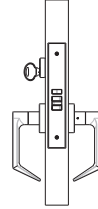

707M Storeroom ANSI F07

- Latch bolt operated by key from outside or by operating inside lever. Outside lever is always inoperative.
- Auxiliary dead latch.

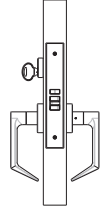

double cylinder without deadbolt

709M Apartment, Exit ANSI F09

- Latch bolt operated by lever from either side, except when outside lever is locked by key from inside.
- When outside lever is locked, latch bolt is retracted by key from outside or by operating inside lever.
- Auxiliary dead latch.

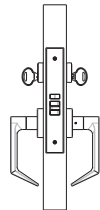

732M Intruder Latch Bolt ANSI F32

- Latch bolt operated by lever from either side except when outside lever is locked from inside or outside by key.
- When outside lever is locked, latch bolt is retracted by key from inside or outside or by operating inside lever.
- Auxiliary dead latch.

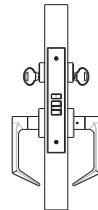

730M Institution ANSI F30

- Latch bolt operated by key from either side. Both levers always inoperative.
- Auxiliary dead latch

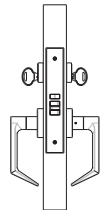

single cylinder with deadbolt

708M Front/Corridor Door (w/toggle) ANSI F08

- Latch bolt is operated by lever from either side, except when outside lever is made inoperative by the toggle.
- Dead bolt is operated by turn inside.
- Key outside operates both bolts.

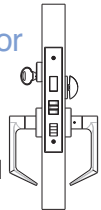

713M Corridor/Dormitory ANSI F13

- Latch bolt operated by lever from either side. Dead bolt projected by key from outside and turn from inside.
- Operating inside lever retracts both bolts and unlocks outside.

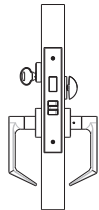

720M Entrance (w/toggle) ANSI F20

- Latch bolt operated by lever from either side, except when outside lever is made inoperative by the toggle.
- Dead bolt operated by key outside or turn inside. Key outside operates both bolts.
- Operating inside lever retracts both bolts and outside remains locked.
- Latch bolt is deadlocked when outside lever is made inoperative or when the dead bolt is projected.
- When dead bolt is retracted, lever is unlocked by the toggle.
- Auxiliary dead latch.

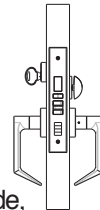

721M Dormitory/Bedroom ANSI F21

- Latch bolt operated by lever from either side.
- Dead bolt operated by key from outside and turn from inside.

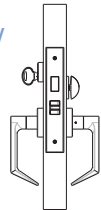

715M Hotel Guest ANSI F15

- Latch bolt is operated by key from outside or by operating inside lever. Outside lever is always inoperative.
- Dead bolt projected by turn from inside, operating inside lever retracts both bolts.
- Auxiliary dead latch.

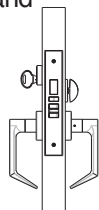

765M Closet/Storeroom

- Latch bolt retracted by lever from either side.
- Dead bolt operated by key outside.

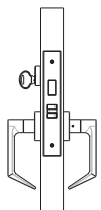

functions

LIFETIME Warranty

double cylinder with deadbolt

711M Dormitory, Exit (w/toggle) ANSI F11

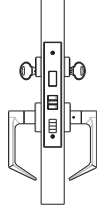

- Latch bolt operated by lever from either side except when outside lever is made inoperative by the toggle.
- Dead bolt projected by key from either side.
- Dead bolt retracted by key from outside.
- Both bolts retracted by inside lever and outside remain locked.

714M Store Door ANSI F14

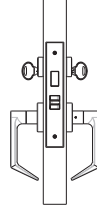

- Latch bolt operated by lever from either side.
- Dead bolt operated by key from either side.

733M Intruder Dead Bolt ANSI F33

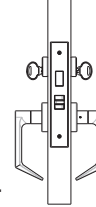

- Latch bolt operated by lever from either side except when outside lever is locked from inside or outside by key.
- Dead bolt retracted by key from inside or outside.
- Operating inside lever retracts both bolts and unlocks outside.

734M Intruder Dead Bolt ANSI F34

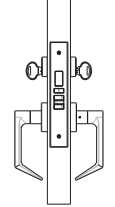

- Latch bolt operated by lever from either side except when outside lever is locked from inside or outside by key.
- Dead bolt retracted by key from inside or outside.
- Operating inside lever retracts both bolts and unlocks outside.
- Auxiliary dead latch.

non-key

701M Passage ANSI F01

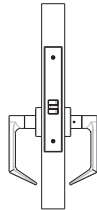

- Latch bolt operated by lever from either side at all times.

702M Privacy ANSI F02

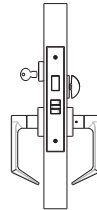

- Latch bolt operated by lever from either side. Dead bolt operated by turn from inside and by emergency release from outside.

719M Privacy ANSI F19

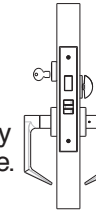

- Latch bolt operated by lever from either side.
- Dead bolt operated by turn from inside and emergency release from outside.
- Operating inside lever retracts both bolts.

722M Privacy ANSI F22

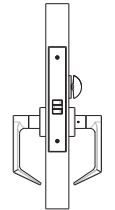

- Latch bolt operated by lever from either side except when outside lever is locked by inside turn or button.
- Operating inside lever, closing door or operating outside emergency release unlocks outside lever.

no trim deadbolt

716M Double Cylinder ANSI F16

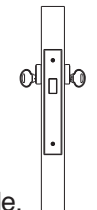

- Dead bolt operated by key from either side.

717M Cylinder & Thumbturn ANSI F17

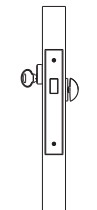

- Dead bolt operated by key from outside and by turn from inside.

778M Single Dummy

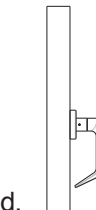

- Lever on one side is always rigid.

776M Double Dummy

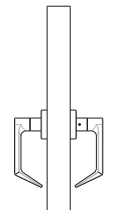

- Lever on both sides are always rigid.

718M Single Cylinder ANSI F18

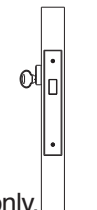

- Dead bolt operated by key from outside only.

729M Classroom ANSI F29

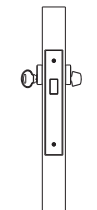

- Key from outside operates dead bolt.
- Turn from inside retracts but does not project dead bolt.

Type #57 for MS

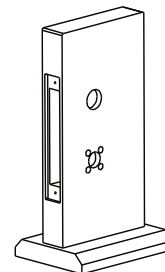

Type #58 for ME

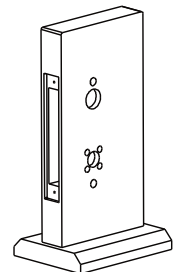

wood stand



**LIBERTY
BUILDING
PRODUCTS**

Barn Door Hardware • Builders Hardware • Commercial Hardware • Hinges
Jambs • Locksets • Pocket Door Frames • PVC Products • Transoms

7 Mary Way • Hainesport, NJ 08036
Tel: 1-609-261-2200 • Fax: 1-609-261-2233
liberty@libertybp.net • www.libertybp.net