



LIBERTY  
BUILDING  
PRODUCTS

# DOOR CLOSERS



**BHMA**  
CERTIFIED™

# DOOR CLOSER

Liberty Building Products is presenting the finest surface mounting door closers certified by BHMA including:



- Multi-size door closer: 9000, 8000, 6000, 6000S (slim cover), 4400 series.
- Standard size door closer: 4000, 3000, 2000 series.
- Multi-size Delay Action door closer: 8000/DA, 6000/DA, 6000S/DA series.

## GENERAL INFORMATION

### ANSI A156.4 – American National Standard for Door Controls-Closers

Grade 1 Door Closers are certified by ANSI/BHMA A156.4.

Grade 2 Door Closers are factory tested to meet or exceed ANSI Grade 2 required strength and performance.

### UL Listed

All door closer series are UL listed, and conform to Standards UL10C and UPC 7-2(1997).

### Meet ADA Requirements

Door closer 9000, 8000, 6000, and 4400 series meet requirements of ANSI A117.1, ADA Standards for Accessible Design, and NFPA 101.

Please note Door Closer with reduced opening force may not provide sufficient power to close a door.

Note: The information below concerning the Americans With Disabilities Act (A.D.A.) has been generated from ANSI/BHMA A117.1, the Federal Register, Part III, published by the Department of Justice, office of the Attorney General, 28CFR, part 36, and NFPA 101. The information listed here are requirements which must be met for door opening accessibility by the handicapped or disabled. Please refer to ANSI/BHMA A117.1, ADA standards and NFPA 101 for specific details.

#### • Door Opening Width

Single-leaf Doorways shall have a clear opening of 32" minimum. Clear opening of doorways with swinging doors shall be measured from the face of door and stop with the door open 90°.

Double-leaf Doorways should have at least one active leaf to meet the minimum opening criteria.

#### • Door Opening Face

Door closers shall be adjusted so that from the open position of 90° the time required to move the door to an open position of 12° shall be 5 seconds minimum.

The maximum force for pushing open or pulling open doors other than fire doors shall be as follows:

1. Interior hinged door: 5 lbs.
2. Exterior hinged door: 8.5 lbs.

\* 4400 series apply to interior hinged door only.

#### • Fire Door (NFPA-101)

The force required to operate the door assembly in the direction of door leaf travel is not more than 30 lbf (133 N) to set the door leaf in motion and is not more than 15 lbf (67 N) to close the door assembly or open it to the minimum required width.

Note: These forces shall be applied at the latch stile. The pound forces stated above should be reduced where possible to comply with exterior hinged door and interior hinged door requirements. However, door closing capability must not be compromised.

#### • Door Closing Speed

ADA: The closing speed from an open position 70° to a point 3" from the latch will take at least 3 seconds.

A117.1: Door closers shall be adjusted so that from the open position of 90° the time required to move the door to an open position of 12° shall be 5 seconds minimum.

**Door Closers Handing** are non-handed and suitable for left-opening or right-opening door

**All Weather Hydraulic Fluid** used to ensure smooth operation under severe weather conditions, operation temperatures 130°F ~ -40°F (55°C ~ -40°C).

**Finish Stock** available Aluminum (BHMA 689) for all model,  
Gold (BHMA 696) for all model

Duranodic (BHMA 695) for all model  
Satin Chrome (BHMA 652) for 8000 series



Aluminum



Duro (Duranodic)



Gold

## ACCESSORIES

**Drop Plate** allows a door closer to be fitted on narrow top rail or narrow top frame door.

Most of the door closers have different kinds of Drop Plates for installation requirements, see following pages in detail.

**Hold Open Arm** used when door is requiring for a clear opening doorways at 90° stop.

\* Should not be used on Fire door application.

**Parallel Rigid Cush Arm** is a heavy duty arm with an auxiliary stop in soffit shoe to stop the door opening at a specific point. Apply to door where wall or floor stops are not appropriate. Parallel arm mounting application only.

**Parallel Rigid Spring Cush Arm** is Parallel Rigid Cush Arm with a Spring Stop in soffit shoe for abusive application.

# DOOR CLOSER

## ACCESSORIES

**Parallel Rigid Hold Open Cush Arm** is a heavy duty hold open arm featured with a plunger hold open to engage or disengage hold open by a handle on the arm. Auxiliary stop in soffit shoe to stop the door opening at a specific point. Parallel arm mounting application only.

\* Should not be used on Fire door application.

**Parallel Rigid Hold Open Spring Cush Arm** is Parallel Rigid Hold Open Cush Arm with a Spring Stop in soffit shoe for abusive application.

\* Should not be used on Fire door application.

**Parallel Rigid Arm** is an extra heavy duty arm that is intended to use in heavy traffic areas. Parallel arm mounting application only.

**Slide Track Arm with Hold Open Stop** provides the smoothest lines available in a surface-mounted door closer. The design minimize projection and eliminate obtrusive arm angles. The arm geometry reduces door closer power efficiency by approximately 25% from that of a regular arm. \* Using hold open stop is not code compliant on fire rated doors.

**Blade Stop Spacer** lowers parallel arm shoe to clear 1/2" (13mm) blade stop.

**Arm Support Bracket** provides anchor for fifth screw, to use with stop arms when reveal is less than 3-1/16" (78mm). (for 8000 door closer only)

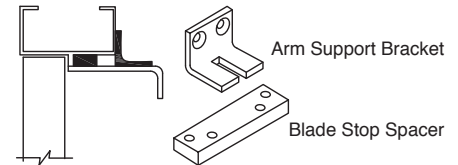

## DOOR CLOSER APPLICATION

There are three basic methods of mounting surface door closers to the door and frame including regular arm, parallel arm and top jamb mounts. All door closers are supplied standard with a tri-pack for mounting any of three types applications.

<p><b>Regular Arm Installation</b> closer mounts on hinge (pull) side of door</p> <p>Left hand door-LH Right hand reverse-RHR Right hand reverse-RHR Right hand reverse-RHR</p> <p>Right hand door-RH Left hand reverse-LHR Left hand reverse-LHR Left hand reverse-LHR</p>	<p><b>Top Jamb Installation</b> closer mounts on frame face on opposite to hinge (pull) side of door</p> <p>Left hand door-LH Right hand reverse-RHR Right hand door-RH Left hand reverse-LHR</p>	<p><b>Parallel Arm Installation</b> closer mounts on opposite to hinge (pull) side of door</p> <p>Left hand door-LH Right hand reverse-RHR Right hand door-RH Left hand reverse-LHR</p>
<p>Right hand door Left hand door</p> <p>valves door swing arm preload</p>	<p>Left hand door Right hand door</p> <p>door swing valves arm preload</p>	<p>Right hand door Left hand door Right hand door</p> <p>door swing 1-1/2" (38mm) Flat Flat</p>
<p><b>Regular Arm (Pull side)</b> <b>Most power-efficient application</b> The Closer body is mounted on the hinge side of the door top rail. The forearm is mounted to the frame face by a mounting shoe. Arm projects at approximately a 90° angle away from the door.</p>	<p><b>Top Jamb (Push side)</b> <b>More power-efficient than the parallel arm application</b> Applying to a closer with narrow top rail on a door. The closer body is mounted to the frame face above the door, opposite the door hinge side. The forearm is then mounted to the top rail of the door.</p>	<p><b>Parallel Arm (Push side)</b> <b>Least power-efficient application</b> The closer body is mounted on the top rail of the door, opposite the hinge side of the door. The forearm is mounted by a parallel arm bracket to the underside of the frame. The arm is parallel to the door, which makes it less likely to be damaged. * Top reveal should have enough space for using this application.</p>

## CLOSER ADJUSTMENT

Door closers have hex wrench controlling valves for adjusting Closing speed and latch speed. Multi-size door closers have a nut for spring power adjustment, and additional valve for Backcheck. Delay Action control valve available with Delay Action model.

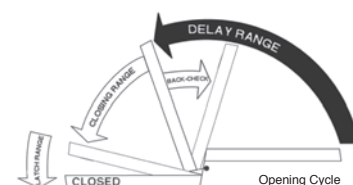

# DOOR CLOSER

**Closing speed & Latching speed** are dual valve control for door closing speed.

Closing speed is the speed of door closing from full opening to approximately 10°~5° of door closed position.

Latching speed is the speed from approximately 10°~5° door opening to door closed position. Slow latch speed provides less door closing noise.

**Backcheck** slows down the door opening at approximately 70° in order to prevent damage to building and door frames. The backcheck control valve provides a 20° adjustment (70° ~ 90°) to set the optimum backcheck start point.

\* Multi-size door closers are standard with Backcheck function.

**Delay Action** is the 3rd control for closing speed adjustment.

It effective from full opening to approximately 70°, and provides a slow closing speed. The closing time between 180° to 70° is at least 20seconds, and easily adjustable up to 1minutes. Closer with Delay Action provides sufficient time that allows people or the elderly to get through the door before it starts to close.

## Multi-size Spring adjustment

Multi-size door closers are able to adjust the spring power to meet the power needs of the door. Spring power of the closer can be increased by turning the power adjustment nut clockwise, vice versa.

## Unit adjustment

Closing speed controls (figure 1,2 and 6 )

- Valve "S" controls sweep range
- Valve "L" controls latch range
- Valve "D" controls delayed action range

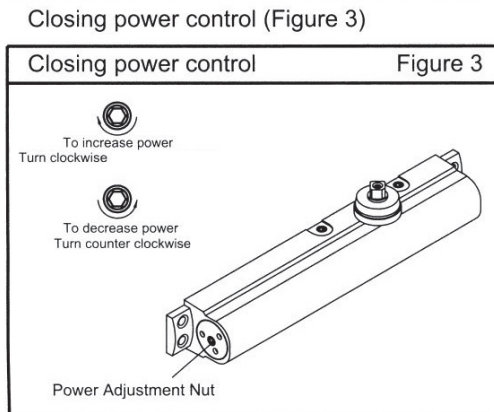
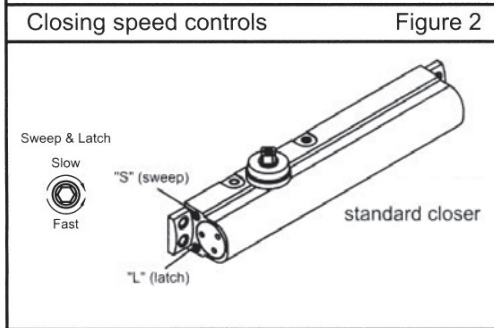
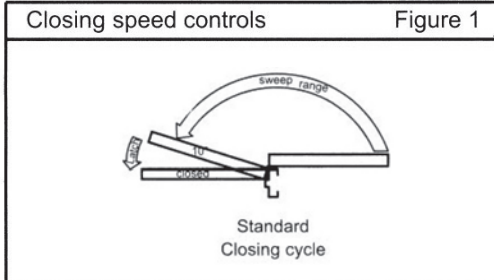

Opening door control (figure 4 and 5)

- Backcheck ("B") Valve controls the hydraulic resistance to door opening. NEVER close this valve completely- it is not to provide a positive stop

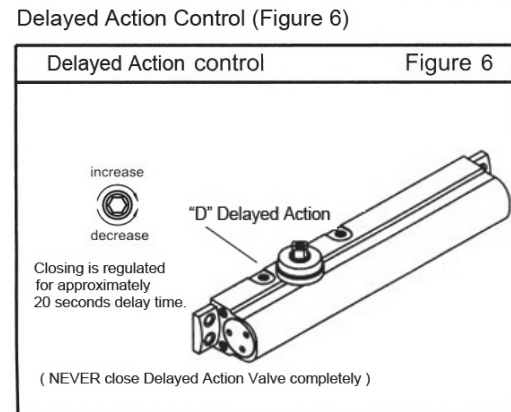
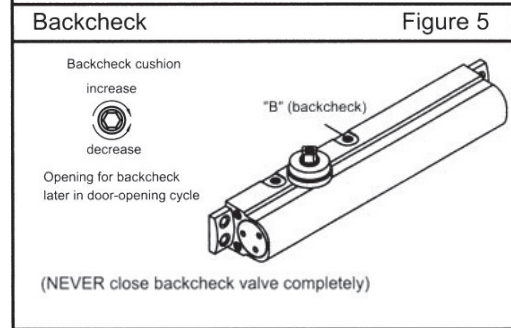
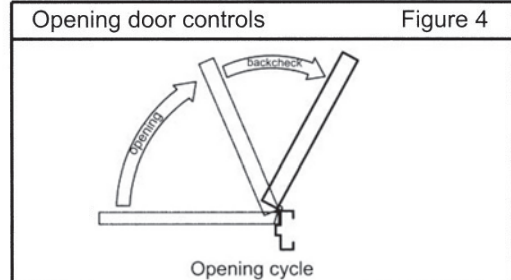

## Closer Size (Spring Power)

Closer Size	Recommended Maximum Door Size					Door Weight (Lbs.)
	Regular & Top Jamb			Parallel Arm		
	Interior	Exterior Swing-in (Pull Side)	Exterior Swing-out (Push Side)	Interior Swing-out (Push side)	Exterior Swing-out (Push side)	
1	28"	N/A	N/A	N/A	N/A	33 ~ 66
2	36"	N/A	N/A	30"	N/A	66 ~ 99
3	42"	30"	36"	36"	30"	99 ~ 143
4	48"	36"	42"	42"	36"	143 ~ 187
5	54"	42"	48"	48"	42"	187 ~ 264
6	60"	48"	54"	54"	48"	264 ~ 330

\* Multi-size door closers provide the spring power required to fit your door size and application.

# 9000 SERIES

**ANSI GRADE 1**

**ANSI GRADE 1**

ANSI/BHMA A156.4

Series 2000, PT1

Exceeds 1,500,000 cycles with Backcheck



UL10C Positive Pressure Rated. Conforms to UBC 7-2 (1997). (Uniform Building Code Standard)

**LISTED**



Comply with ANSI A117.1

**25-Year Warranty**



**Model**

**9000**

Adjustable power size 1-6 with Back Check

**9000/DA**

Adjustable power size 1-6 with Back Check and Delay Action

**Applications**

- Heavy Duty Commercial model ideal for high traffic door such as schools, hospitals, and public institutions
- Same mounting hole pattern as CAL-ROYAL 900 (CTC 11-1/8" x 1-1/8"), ideal for renovations
- Tri-packed for all type applications
- Sex-bolts included for Metal Door mounting



**Features**

- Multi-size spring adjustable power size 1-6
- Factory preset size 3
- Meet ADA
- Standard with adjustable Backcheck

**Product Specification**

Material	Aluminum alloy body, forged steel arm Heat treated forged steel piston Double Heat treated Steel pinion
Cover	Full plastic cover – standard
Valves	Triple valve control for Closing speed, Latching speed, and Back-check Staked valve for power adjustment
Arm & Brackets	Standard arm and parallel bracket included for different mounting demand
Screws	Self-tapping wood screws, machine screws, and sex-bolts
Finishes	Aluminum, Durotonic, and Gold

**Optional Functions**

- Hold Open Arm (9001)
- Parallel Rigid Cush Arm (9002)
- Parallel Rigid Cush and Stop Arm (9003)
- Extended Forearm (9004)
- Parallel Rigid Arm (9005)
- Slide Track Arm (9006)
- Drop Plate (90DP-PA)
- \* **Special Order from the factory**
- Metal Cover
- Finish (BHMA): US3 (632), US4 (633), US26 (651), US26D (652), US32D (630)

**Technical Dimensions**

Series 9000	Size	
A. Length of Closer Body	11-7/8"	
B. Horizontal Mounting Holes	11-1/8"	
C. Vertical Mounting Holes	1-1/8"	
D. Height of Closer Body	2"	
E. Projection from Door	2-3/8"	

**Accessories**



**9001 Hold-open Arm**  
Stand for pull side & top jamb  
Use with PA bracket for parallel arm mount



**9002 Parallel Rigid Cush Arm**  
Auxiliary Stop in soffit shoe



**9003 Parallel Rigid Hold Open Cush Arm**  
Hand control plunger hold open  
Auxiliary stop in soffit shoe



**9005 Parallel Rigid Arm**  
Featured with solid steel main & forearm for extra heavy traffic use



**9004 Extended Forearm**  
For Top Jamb with reveal greater than 4" and up to 8"

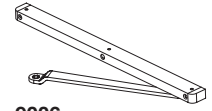

**9006 Slide Track Arm**  
Featured with adjustable Hold Open Angle

**HF01 Flat Wrench for Hold Open Arm**

**PAB01 Parallel Bracket**  
For Hold Open Arm mounting can also use for regular parallel arm application

**BSS02 Blade Stop Spacer**  
Design to lower parallel arm shoe to clear 1/2" (13 mm) blade stop

**90DP-PA Drop Plate –Parallel arm mount**  
Size: 11-13/16" x 3-9/16"  
Used to mount a closer on a top rail as narrow as 1-9/16" in height

**90C Standard Full Plastic Cover**

**1349 Sex-bolt with screw**  
For 1-3/4" standard Door Thick

# 8000 SERIES

**ANSI GRADE 1**

**ANSI GRADE 1**

ANSI/BHMA A156.4

Series 2000, PT1

Exceeds 1,500,000 cycles with Backcheck



**LISTED**

UL10C Positive Pressure Rated. Conforms to UBC 7-2 (1997). (Uniform Building Code Standard)



Comply with ANSI A117.1

**25-Year Warranty**



**Model**

**8000**

Adjustable power size 1-6 with Back Check

**8000/DA**

Adjustable power size 1-6 with Back Check and Delay Action

**Applications**

- Extra Heavy Duty Commercial model ideal for high traffic door
- Versatile for new constructions, such as schools, hospitals, and public institutions
- Same mounting hole pattern as LCN4041, ideal for renovations
- Tri-packed for all type applications
- Sex-bolts included for Metal Door mounting

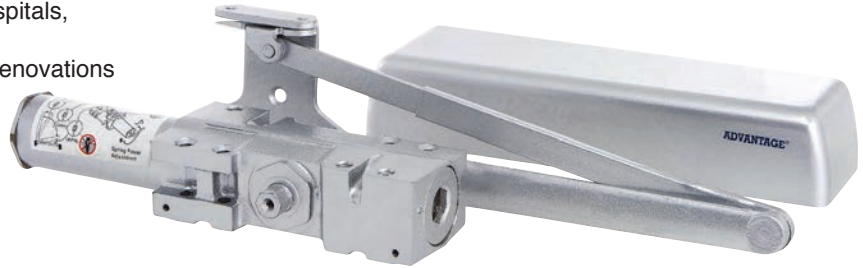

**Features**

- Multi-size spring adjustable power size 1-6
- Factory preset size 3
- Meet ADA

Product Specification	
Material	Heavy Duty Cast Iron body, forged steel arm Heat treated forged steel piston Double Heat treated Steel pinion
Cover	Full plastic cover – standard
Valves	Triple valve control for Closing speed, Latching speed, and Back-check cushion Delayed Action valve – Optional (Model: 8000/DA) Staked valve for power adjustment
Arm & Brackets	Standard arm and parallel bracket included for different mounting demand
Screws	Self-tapping wood screws, machine screws, and sex-bolts
Finishes	Aluminum, Duronotic, Gold, and US26D-Satin Chrome

**Optional Functions**

Wide choice of options for different applications

- Hold Open Arm (8001)
- Parallel Rigid Cush Arm (8002)
- Parallel Rigid Cush and Stop Arm (8003)
- Extended Forearm (8004)
- Parallel Rigid Arm (8005)
- Slide Track Arm (8006)
- Drop Plate (see Accessories)
- \* **Special Order from the factory**
- Metal Cover

Finish (BHMA): US3 (632), US4 (633), US26 (651), US26D (652), US32D (630)

Technical Dimensions		Diagram	
Series 8000	Size	End View	Front View
A. Length of Closer Body	11"		
B. Horizontal Mounting Holes	5"		
C. Vertical Mounting Holes	1"		
D. Height of Closer Body	2-3/4"		
E. Projection from Door	2"		

**Accessories**

**80DP-ST**  
Size: 12-1/4 x 3-9/16"



**Drop Plate – Pull Side**  
Hinge side mount when top rail is less than 3-3/4"  
Plate require 2" minimum top rail

**80DP-TJ**  
Size: 12-1/4 x 3-9/16"



**Drop Plate – Top Jamb**  
Use when frame face is less than 3 1/2"  
Use 8004 forearm if top reveal exceeds 2-9/16"

**80DP-TG**  
Size: 12-1/4 x 3-9/16"



**Drop Plate – Top Jamb with flush ceiling**  
Top of head frame face in flush ceiling condition  
Plate requires 1-3/4" minimum frame face  
Use 8004 forearm if top reveal exceeds 2-9/16"

**80DP-PA**  
Size: 12-1/4 x 5"



**Drop Plate – Parallel Arm**  
Use when top rail is less than 5-1/2", measured from the stop  
Plate requires at least 2-1/2" top rail



**8001 Hold-open Arm**  
Stand for pull side & top jamb  
Use with PA bracket for parallel arm mount



**8002 Parallel Rigid Cush Arm**  
Auxiliary Stop in soffit shoe



**8003 Parallel Rigid Hold Open Cush Arm**  
Hand control plunger hold open  
Auxiliary stop in soffit shoe



**8005 Parallel Rigid Arm**  
Featured with solid steel main & forearm for extra heavy traffic use

**HFW01 Flat Wrench** for Hold Open Arm



**8004 Extended Forearm**

For Top Jamb with reveal between 2-5/8" to 4-13/16"



**ASB01 Arm Support Bracket**

Use with Cush Arms when reveal is less than 3-1/16" (78 mm). The bracket provides anchorage for fifth screw loading



**PAB01 Parallel Bracket**

For Hold Open Arm mounting can also use for regular parallel arm application



**BSS01 Blade Stop Spacer**

Design to lower parallel arm shoe to clear 1/2" (13 mm) blade stop



**80C Standard Full Plastic Cover**



**1348 Sex-bolt with screw**



# 6000, 6000S SERIES

**ANSI GRADE 1**

**ANSI GRADE 1**

**ANSI/BHMA A156.4**

Series 2000, PT1

Exceeds 1,500,000 cycles with Backcheck



UL10C Positive Pressure Rated. Conforms to UBC 7-2 (1997). (Uniform Building Code Standard)

**LISTED**



Comply with ANSI A117.1

**25-Year Warranty**



## Model

**6000, 6000S**

**6000/DA, 6000S/DA**

Adjustable power size 1-6 with Back Check

Adjustable power size 1-6 with Back Check and Delay Action

## Applications

- Heavy Duty Commercial model ideal for high traffic door
- Versatile for new constructions, such as schools, hospitals, and public institutions
- Same mounting hole pattern as NORTON 8000 CTC 12" x 3/4", ideal for renovations
- Tri-packed for all type applications
- Sex-bolts included for Metal Door mounting

## Features

- Multi-size spring adjustable power size 1-6, Factory preset size 3
- Meet ADA
- Standard with adjustable Backcheck



## Product Specification

Material	Aluminum alloy body, forged steel arm Heat treated forged steel piston Double Heat treated Steel pinion
Cover	Full plastic cover – 6000 series
Valves	Triple valve control for Closing speed, Latching speed, and Back-check Delayed Action valve – Optional (Model: 6000/DA, 6000S/DA) Staked valve for power adjustment
Arm & Brackets	Standard arm and parallel bracket included for different mounting demand
Screws	Self-tapping wood screws, machine screws, and sex-bolts
Finishes	Aluminum, Durotonic, and Gold

## Optional Functions

Wide choice of options for different applications

- Hold Open Arm (6001)
  - Parallel Rigid Cush Arm (6002)
  - Parallel Rigid Cush and Stop Arm (6003)
  - Extended Forearm (6004)
  - Parallel Rigid Arm (6005)
  - Slide Track Arm (6006)
  - Drop Plate (see Accessories)
  - Drop Plate (Full Cover only)
  - \* **Special Order from the factory**
  - Metal Cover (Full Cover only)
- Finish (BHMA): US3 (632), US4 (633), US26 (651), US26D (652), US32D (630)

## Technical Dimensions

Series 6000, 6000S	Size	
A. Length of Closer Body	12-3/4"	
B. Horizontal Mounting Holes	12"	
C. Vertical Mounting Holes	3/4"	
D. Height of Closer Body	1-1/4"	
E. Projection from Door	2-1/8"	



**6001 Hold-open Arm**  
Stand for pull side & top jamb  
Use with PA bracket for parallel arm mount



**6002 Parallel Rigid Cush Arm**  
Auxiliary Stop in soffit shoe



**6003 Parallel Rigid Hold Open Cush Arm**  
Hand control plunger hold open  
Auxiliary stop in soffit shoe



**6005 Parallel Rigid Arm**  
Featured with solid steel main & forearm for extra heavy traffic use

**HF01 Flat Wrench** for Hold Open Arm

**PAB01 Parallel Bracket**  
For Hold Open Arm mounting  
can also use for regular parallel arm application

**BSS02 Blade Stop Spacer**  
Design to lower parallel arm shoe to clear 1/2" (13 mm) blade stop

**6004 Extended Forearm**  
For Top Jamb with reveal greater than 4" and up to 8"

**6006 Slide Track Arm**  
Featured with adjustable Hold Open Angle

**60C-S Standard Slim Plastic Cover**

## Accessories

**60DP-ST**

Size: 13-1/8 x 3-1/4"

**Drop Plate – Pull Side , or**

**Concealed Door Holder**

Use for hinge side mount

Upside-down to mount where concealed door

holder prevents normal door closer mounting

Plate require 2-7/16" minimum top rail

**60DP-TJ**

Size: 13-1/8 x 3-5/8"

**Drop Plate – Top Jamb**

Apply to low ceiling clearance between

1-1/2" ~ 1-3/4"

**60DP-PAS**

Size: 13-1/8 x 3-5/8"

**Drop Plate – Parallel Arm**

Plate require 2-7/8" minimum top rail

Cross reference: NORTON #3148

**60DP-PA**

Size: 13-1/8 x 5"

**Drop Plate –**

**Parallel arm mount**

Used to mount a closer on a top rail as

narrow as 3" in height

**1344 Sex-bolt with screw**

**60C-F**

**Standard Full**

**Plastic Cover**

# 4400 SERIES

**ANSI GRADE 1**

## ANSI GRADE 1

ANSI/BHMA A156.4

Series 2000, PT1

Exceeds 1,500,000 cycles with Backcheck



**LISTED**

UL10C Positive Pressure Rated. Conforms to UBC 7-2 (1997). (Uniform Building Code Standard)



**4400 Series**  
Comply with  
ANSI A117.1

**25-Year Warranty**



## Model

**4400**

Adjustable power size 1-6 with Back Check

## Applications

- Heavy Duty Commercial model, ideal for high traffic door
- Versatile for new constructions, such as schools, hospitals, and public institutions
- Universal mounting hole pattern
- Size 4: CTC 9-1/16" x 3/4"
- Tri-packed for all type applications
- Sex-bolts included for Metal Door mounting



## Features

- Multi-size spring adjustable power size 1-6, factory preset size 3
- 4400 meets ADA, Barrier Free interior
- Standard with adjustable Backcheck

## Product Specification

Material	Aluminum alloy body, forged steel arm Heat treated forged steel piston Double Heat treated Steel pinion
Cover	Full plastic cover – standard
Valves	Triple valve control for Closing speed, Latching speed, and Back-check Staked valve for power adjustment
Arm & Brackets	Standard arm and parallel bracket included for different mounting demand
Screws	Self-tapping wood screws, machine screws, and sex-bolts
Finishes	Aluminum, Durototic, and Gold

## Optional Functions

- Hold Open Arm (4001)
- Drop Plate (see Accessories)

### \* Special Order from the factory

- Metal Cover  
(Slim Cover with power size 1-4 only)  
Finish (BHMA): US3 (632), US4 (633),  
US26 (651), US26D (652) , US32D (630)

## Technical Dimensions

Series 5000, 4400	Size			
A. Length of Closer Body	9-3/4"	9-3/4"		
B. Horizontal Mounting Holes	9-1/16"	9-1/16"		
C. Vertical Mounting Holes	3/4"	3/4"		
D. Height of Closer Body	1-3/4"	1-3/4"		
E. Projection from Door	2-7/8"	2-7/8"		
			End View	Front View

## Accessories

### 4001

#### Hold-open Arm

Stand for pull side and top jamb

Use with PA bracket for parallel arm mount



### HFW01

#### Flat Wrench

For Hold Open Arm



### PAB02

#### Parallel Bracket

for Hold Open Arm mounting can also use for regular parallel arm application



### 40C

#### Standard Full Plastic Cover



### 1344

#### Sex-bolt with screw

For 1-3/4" standard Door Thick



### BSS02

#### Blade Stop Spacer

Design to lower parallel arm shoe to clear 1/2" (13 mm) blade stop



### 40DP-TJ

Size: 9-3/4" x 2-9/16"

#### Drop Plate –Top Jamb low ceiling clearance

For use when ceiling clearance is between 1-3/4" and 2-5/8"

Cross reference: NORTON #1687

### 40DP-PA

Size: 9-3/4" x 3-1/2"

#### Drop Plate –Parallel arm mount

Used to mount a closer on a top rail as narrow as 2-5/8" in height

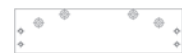



# 4000, 3000, 2000 SERIES ANSI GRADE 2

## GRADE 2

Factory tested to meet ANSI Grade 2 durability



LISTED

UL10C Positive Pressure Rated. Conforms to UBC 7-2 (1997). (Uniform Building Code Standard)

10-Year Warranty



## Model

**4000** Standard power size 4  
**3000** Standard power size 3  
**2000** Standard power size 2

## Applications

- Medium and Light Duty model  
 Medium Duty 4000  
 Light Duty 3000, 2000
- Universal mounting hole pattern  
 Size 4: CTC 9-1/16" x 3/4"  
 Size 3: CTC 8-3/16" x 3/4"  
 Size 2: CTC 6-5/8" x 3/4"



## Product Specification

Material	Aluminum alloy body, forged steel arm Heat treated forged steel piston Double Heat treated Steel pinion
Valves	Dual valves control for Closing speed and Latching speed.
Arm & Brackets	Standard arm and parallel bracket included for different mounting demand
Screws	Wood screws and machine screws
Finishes	Aluminum, Durotonic, and Gold

## Optional Functions

- Hold Open Arm (3001, 4001)
- Drop Plate (See Accessories)
- Sex-bolts (Metal door mounting)
- Full plastic cover, available for 4000 series only (40C)

## Technical Dimensions

Series 4000, 3000, 2000	Size		
A. Length of Closer Body	9-3/4"	8-3/4"	7-5/16"
B. Horizontal Mounting Holes	9-1/16"	8-3/16"	6-5/8"
C. Vertical Mounting Holes	3/4"	3/4"	3/4"
D. Height of Closer Body	1-3/4"	1-3/4"	1-3/4"
E. Projection from Door	2-7/8"	2-7/8"	2-5/8"

End View

Front View

## Accessories

**4001**  
**Hold-open Arm**  
 For 4000 Series  
 Pull side and top jamb  
 Use with PA bracket for parallel arm mount



**3001**  
**Hold-open Arm**  
 For 3000 Series  
 Pull side and top jamb  
 Use with PA bracket for parallel arm mount



**40DP-TJ** For 4000 Series  
 Size: 9-3/4" x 2-9/16"  
**Drop Plate –Top Jamb**  
**low ceiling clearance**  
 For use When ceiling clearance is between 1-3/4" and 2-5/8"

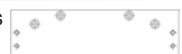

**HFW01**  
**Flat Wrench**  
 For Hold Open Arm



**40C**  
 For 4000 Series  
**Standard Full Plastic Cover**



**40DP-PA** For 4000 Series  
 Size: 9-3/4" x 3-1/2"  
**Drop Plate –Parallel arm mount**  
 Used to mount a closer on a top rail as narrow as 2-5/8" in height



**PAB02**  
**Parallel Bracket**  
 for Hold Open Arm mounting can also use for regular parallel arm application



**1344**  
**Sex-bolt with screw**  
 For 1-3/4" standard Door Thick



**30DP-PA** For 3000 Series  
 Size: 3-1/2" x 8-3/4"  
**Drop Plate – Parallel arm mount**  
**20DP-PA** For 2000 Series  
 Size: 3-1/2" x 7-5/16"  
**Drop Plate – Parallel arm mount**



# ORDER INFORMATION

Product Availabilities													
Series	Power Size	Duty	Function Availability			Accessories							
			Back Check	Delay Action	Hold Open with Hold Open Arm	Parallel Rigid Cush Arm	Cush & Stop Arm	Parallel Rigid Arm	Side Track Arm	Drop Plate	Sex-Bolt	Plastic Cover	Metal Cover
9000	Adjustable No. 1-6	Heavy	●		●	●	●	●	●	●	●	●	●
9000/DA	Adjustable No. 1-6	Heavy	●	●	●	●	●	●	●	●	●	●	●
8000	Adjustable No. 1-6	Extra Heavy	●		●	●	●	●	●	●	●	●	●
8000/DA	Adjustable No. 1-6	Extra Heavy	●	●	●	●	●	●	●	●	●	●	●
6000	Adjustable No. 1-6	Heavy	●		●	●	●	●	●	●	●	●	●
6000S	Adjustable No. 1-6	Heavy	●		●	●	●	●	●	●	●	●	
6000/DA	Adjustable No. 1-6	Heavy	●	●	●	●	●	●	●	●	●	●	●
6000S/DA	Adjustable No. 1-6	Heavy	●	●	●	●	●	●	●	●	●	●	
4400	Adjustable No. 1-6	Heavy	●		●					●	●	●	●
4000	No. 4	Medium			●					●	●	●	
3000	No. 3	Light			●					●	●		
2000	No. 2	Light								●	●		

● Standard or optional

● Special order from the factory, allow for longer lead time. Please call for more information

Door Closers	Power Size		Product Code		
<b>Adjustable Power with Back-Check (BC)</b>			Aluminum	Duro	Gold
9000	No. 1-6 BC	♿	609910	609911	609912
8000	No. 1-6 BC	♿	608810	608811	608812
6000	No. 1-6 BC	♿	606710	606711	606712
6000S (Slim Cover)	No. 1-6 BC	♿	606730	606731	606732
4400	No. 1-6 BC	♿	604410	604411	604412
<b>Adjustable Power with Back-Check (BC) and Delay Action (DA)</b>					
9000/DA	No. 1-6 BC DA	♿	609940	609941	609942
8000/DA	No. 1-6 BC DA	♿	608840	608841	608842
6000/DA	No. 1-6 BC DA	♿	606740	606741	606742
6000S/DA (Slim Cover)	No. 1-6 BC DA	♿	606750	606751	606752
<b>Fixed Power Size</b>					
4000	No. 4		604010	604011	604012
3000	No. 3		603300	603301	603302
2000	No. 2		602200	602201	602202

# CROSS REFERENCE

DOOR CLOSER	9000	8000	6000	6000S	4400	4000	3000	2000
Spring Power Size	1 – 6	1 – 6	1 – 6	1 – 6	1 – 6	4	3	2
CTC Hole Pattern	11-1/8" x 1-1/8"	5" x 2-1/4" x 1"	12" x 3/4"	12" x 3/4"	9-1/16" x 3/4"	9-1/16" x 3/4"	8-3/16" x 3/4"	6-5/8" x 3/4"
CAL-ROYAL	N900-PBF	CR441	CR801	CR801S	300	740 440-FP	730 430-P	● 720 ● 420-P
CRL	PR74BC	PR90			● PR80/PR82BF PR80 Size 2-5	DC54 Size 4	DC53 Size 3	● DC52 Size 2
DESIGN HARDWARE		416	316		116	100	100	100
DORMA		● 8916	8616		● 7400	● 7304 ● 7204	● 7303 ● 7203	
FALCON DOR-O-MATIC		● SC70	SC81		● SC60/SC61 SC60 Size 2-5	SC64 SC94	● SC93	
GLOBAL DOOR CONTROL	● TC600	TC4300	TC500	TC400	TC200	TC204	TC2203	● TC302 ● TC2202
HAGER		5100	5200		5300	5400	● 5400	● 5400
INTERNATIONAL DOOR CLOSER	● 9000	44CI	5000		8050	854 ● 754 654	853 753 653	● 852 ● 752 ● 652
LCN		4040			● 1260 Size 1-5			
NORTON		● 7500	8501	8301	1600			
PDQ Manufacturing		7100	5300		1100/3100	1100/3100		
SARGENT	● 1431	● 281	1331		1130	1134		
S.PARKER	900BC				● BF900 814BC	534	533	● 532
TAYMOR	1900				● 800/800BF 800 Size 2-5	● 604	● 603	602
TELL	● 700	900	800		600	500		
YALE		4400	3501 YMDC2501	3301	50 YMDC1101	● 5104	● 5103	● 5102

● The same mounting hole pattern with similar application    ● Different mounting hole pattern in the same power size  
All brand names & trademarks used are properties of their respective owners



**MDH01E**  
Flush Mount Type



LISTED



**MDH02E**  
Surface Mount Type

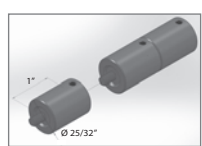

**AEXT-01**  
1" Armature Extension Bolt  
(can be connected for  
2" & 3" long)

## Electromagnetic Door Holder



Barn Door Hardware • Builders Hardware • Commercial Hardware • Hinges  
Jambs • Locksets • Pocket Door Frames • PVC Products • Transoms

7 Mary Way • Hainesport, NJ 08036  
Tel: 1-609-261-2200 • Fax: 1-609-261-2233  
liberty@libertybp.net • www.libertybp.net