

COMMANDER Omni Fiberglass Antenna, 440-450, 12.1dBi, 7-16 DIN Female

 Please visit us on the internet at <http://www.commandertech.com>
Product Description

Commander VHF base Station Antennas incorporate the design enhancements not normally available in other fiberglass collinear antennas of comparable size. Due to their broadband characteristics, only six versions are required to cover 450-512 MHz band. The 455 combines full 10 MHz bandwidth capability and improved lightning protection with 10 dBd omni-directional gain while preserving the desirable light-weight characteristic found in all Commander antennas



455 Series

Features/Benefits

Fiberglass construction protects radiating elements in corrosive environments. Copper radiating elements minimize possibility of intermod generation. Full 10 dB gain - provides maximum on horizon coverage

Technical Specifications

Frequency Band	300-699.9 MHz
Horizontal Pattern	Omni Directional
Antenna Type	Fiberglass Omni
Electrical Down Tilt Option	Fixed
Gain, dBi (dBd)	12.1 (10)
Frequency Range, MHz	440-450
Connector Type	7-16 DIN Female
Connector Location	Bottom
Mounting Type	Fixed
Electrical Down Tilt, deg	0
Orientation	Upright
Mounting Hardware	46 Clamp Set
Rated Wind Speed, km/h (mph)	160 (100)
Gain (Omni), dBi (dBd)	12.14 (10)
VSWR	< 1.5 : 1
Vertical Beamwidth, deg	7
Polarization	Vertical
Maximum Power Input, W	500
Lightning Protection	Direct Ground
3rd Order IMP @ 2 x 43 dBm, dBc	-130
Impedance, Ohms	50
Overall Length, m (ft)	6.16 (20.2)
Element Housing Length, m (ft)	5.46 (17.9)
Mounting Pipe Diameter, m (in)	0.07 (2.75)
Support Pipe Length, m (ft)	0.61 (2)
Weight, kg (lb)	11 (24)
Radiating Element Material	Copper
Element Housing Material	Fiberglass
Support Pipe Material	Aluminum Alloy
Max Wind Loading Area m ² (ft ²)	0.178 (1.92)
Survival Wind Speed, km/h (mph)	200 (125)
Bend Mom @ Rated Wind 1" Below Top of Mt Pipe, N m (ft lbf)	936 (690)
Wind Load - Side @ Rated Wind, N (lbf)	342 (77)
Shipping Weight, kg (lb)	25.9 (57)
Packing Dimensions, HxWxD mm (in)	7320 x 100 x 100 (288.18 X 3.94 X 3.94)
Packing Dimensions, HxWxD, m (ft)	7.32 x 0.1 x 0.1 (24 x 0.33 x 0.33)
Shipping Dimensions of Accessory, HxWxD, m (ft)	Packed with Antenna
Shipping Mode	Common Carrier

Notes

All information contained in this datasheet is subject to confirmation at time of ordering

COMMANDER Omni Fiberglass Antenna, 440-450, 12.1dBi, 7-16 DIN Female

Please visit us on the internet at <http://www.commandertech.com>

Other Documentation

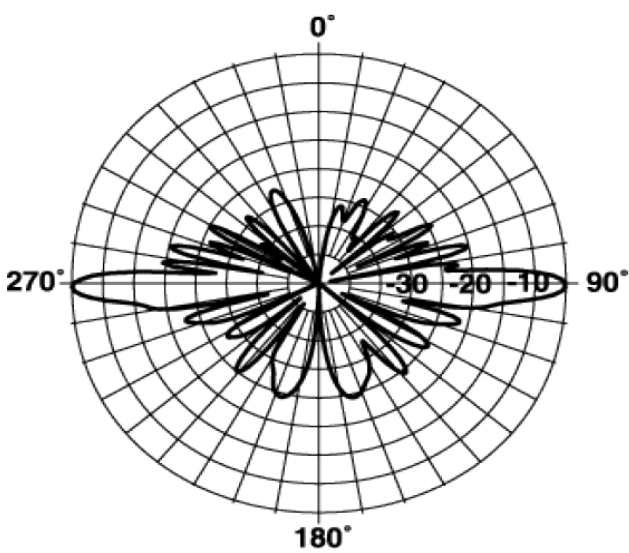

Vertical Pattern

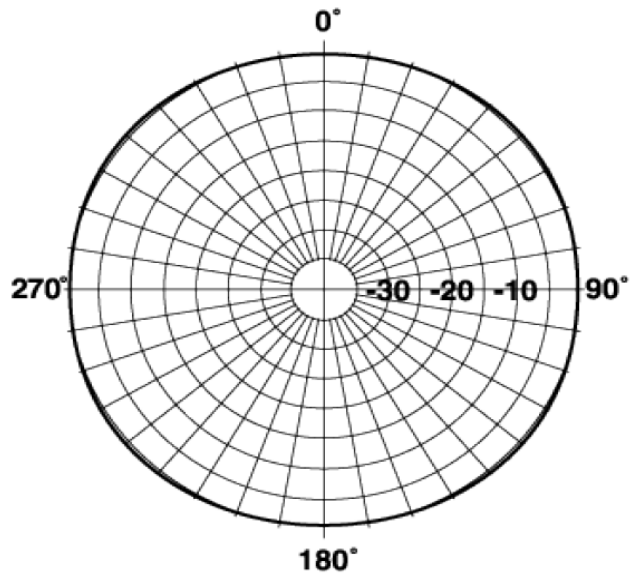

Horizontal Pattern

