



# EIW 20K ALUMINUM SHORING SYSTEM

## Products and Services

### Access Scaffolding Systems

- TSS Total Scaffold System (Steel/Aluminum)
- Total Frame Scaffold System (Aluminum)
- Traditional Frame Scaffolding

### Shoring Systems

- Truss Shoring System (Steel/Aluminum)
- QSS Quick Strip System (Aluminum)
- HD Frame Shoring (Steel/Aluminum)
- Post Shores (Steel/Aluminum)

### Forming System

- Panel Forming System (Steel/Aluminum)
- Mega Form Panel Forming System (Aluminum)
- Gang Forming System (Aluminum)
- Aluminum Beams
- Aluminum Strong Backs

### Technical Services

- Project Analysis
- Technical Training
- On Site Technical Support
- Custom Design

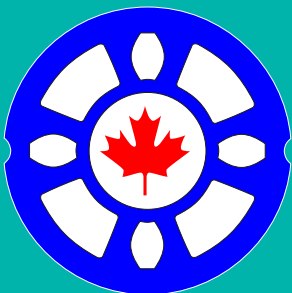
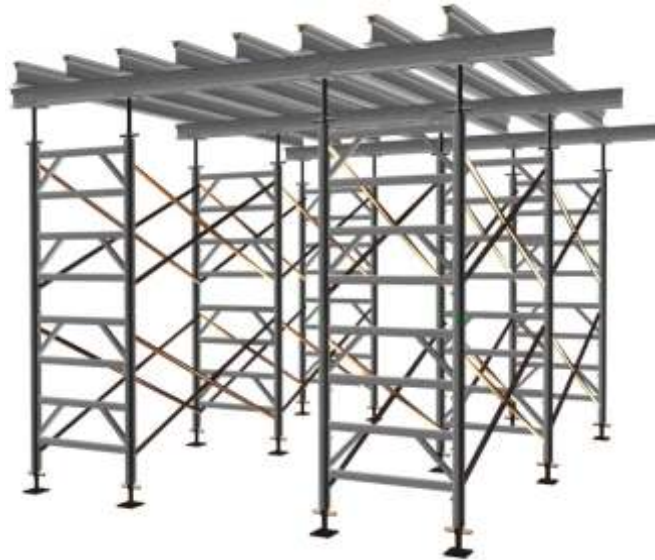

## **Etobicoke Ironworks Limited**

141 Rivalda Road Weston Ontario M9M 2M7

Tel: (416) 742-7111

Fax: (416) 742-2737

email: [info@eiw-ca.com](mailto:info@eiw-ca.com)

[www.eiw-ca.com](http://www.eiw-ca.com)

# COMPONENTS OF 20K FRAME SYSTEM

\* FRAME WIDTH ALSO AVAILABLE IN 4' AND 5'

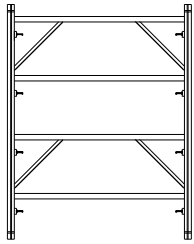

**6' x 8' FRAME**  
Code no 226680  
Weight 55 lbs (25 kg)

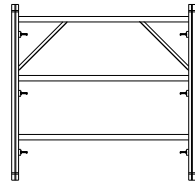

**6' x 6' FRAME**  
Code no 226660  
Weight 40 lbs (20 kg)

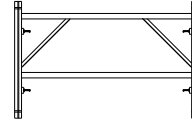

**6' x 4' FRAME**  
Code no 226640  
Weight 28 lbs (14 kg)

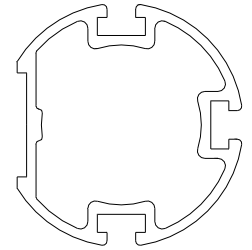

**FRAME LEG PROFILE**

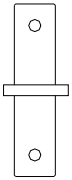

**CONNECTOR**  
Code no 210200  
Weight 2.19 lbs (1.0 kg)

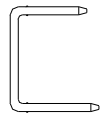

**U-PIN**

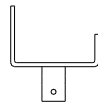

**J-HEAD**



**BASE PLATE FOR FRAME LEG**



**190 ALUMINUM BEAM**



**165 ALUMINUM BEAM**

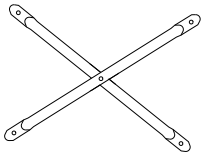

**CROSS BRACE**

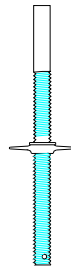

**SCREWJACK**

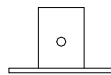

**BASE PLATE FOR SCREWJACK**



**SHORE STAFF**

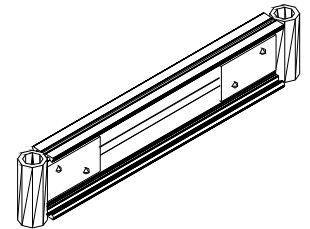

**SADDLE BEAM**

## LOADING CHART

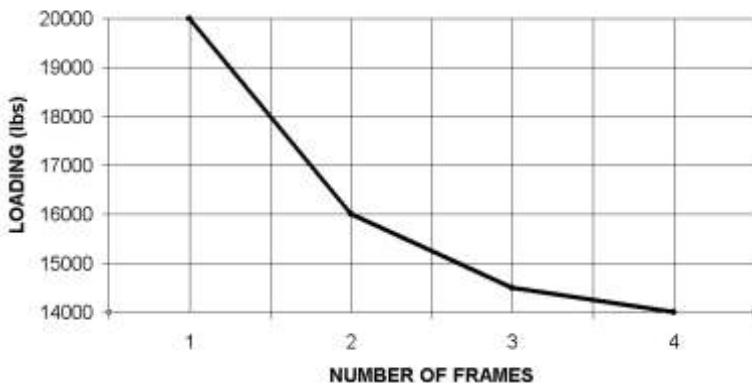

- The above allowable frame loads reflect a 3.0 to 1 safety factor
- The capacity is based on 12" (300 mm) top and bottom screw jack extension
- Horizontal bracing is required when the height exceed 3 times the width of the frame
- For conditions other than the above, consult EIW engineering department

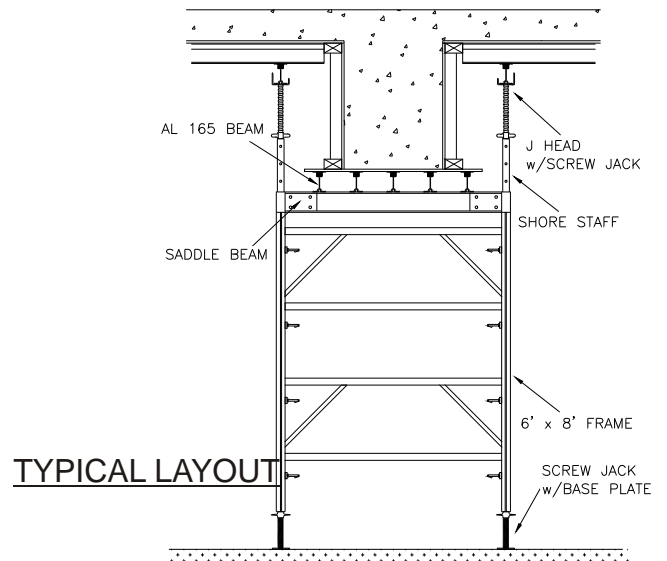

## TYPICAL LAYOUT



## Etobicoke Ironworks Limited

141 Rivalda Road Weston Ontario M9M 2M7  
Tel: (416) 742-7111 Fax: (416) 742-2737  
email: info@eiw-ca.com www.eiw-ca.com

Distributed by: