

QS Trim # 1

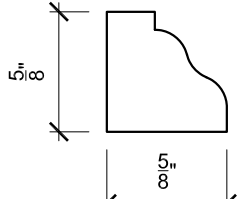

QS Trim # 2

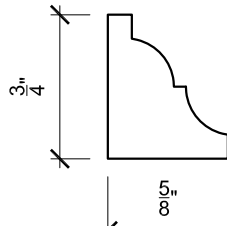

QS Trim # 3

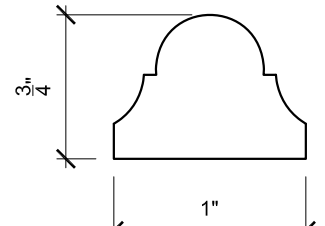

QS Trim # 4-A

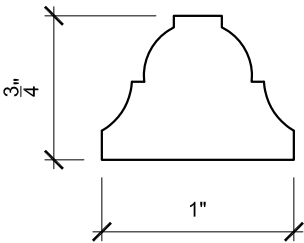

QS Trim # 4-A

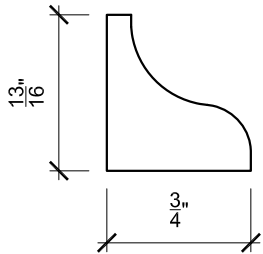

QS Trim # 5

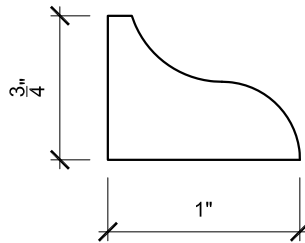

QS Trim # 6

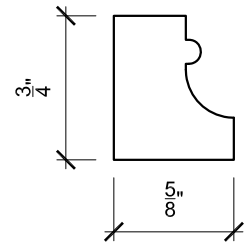

QS Trim # 7

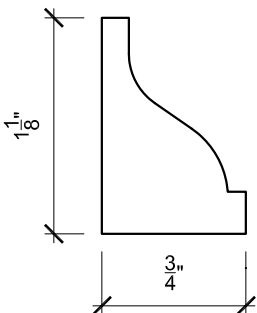

QS Trim # 8  
Knives Only

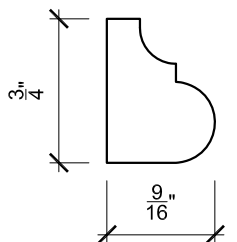

QS Trim # 9

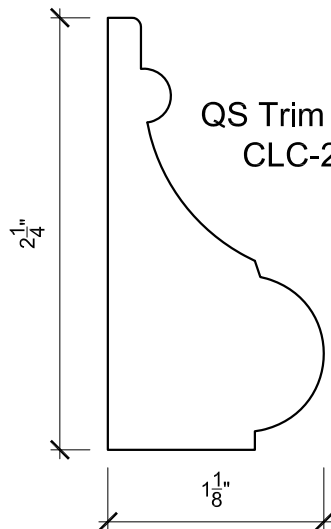

QS Trim # 10  
CLC-23

QS Trim # 10  
CLC-23

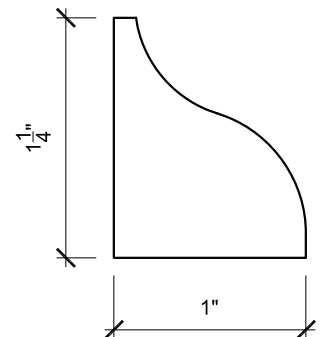

QS Trim # 11

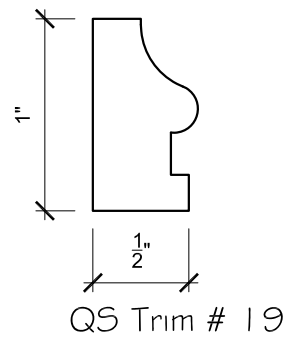
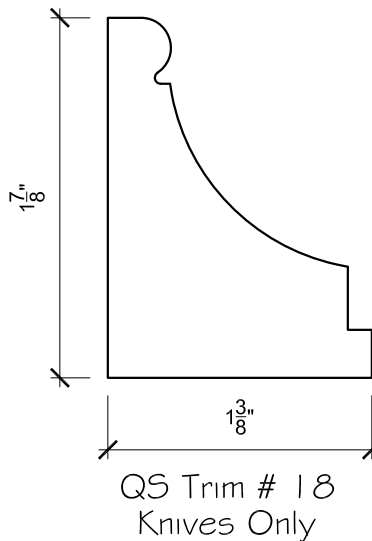
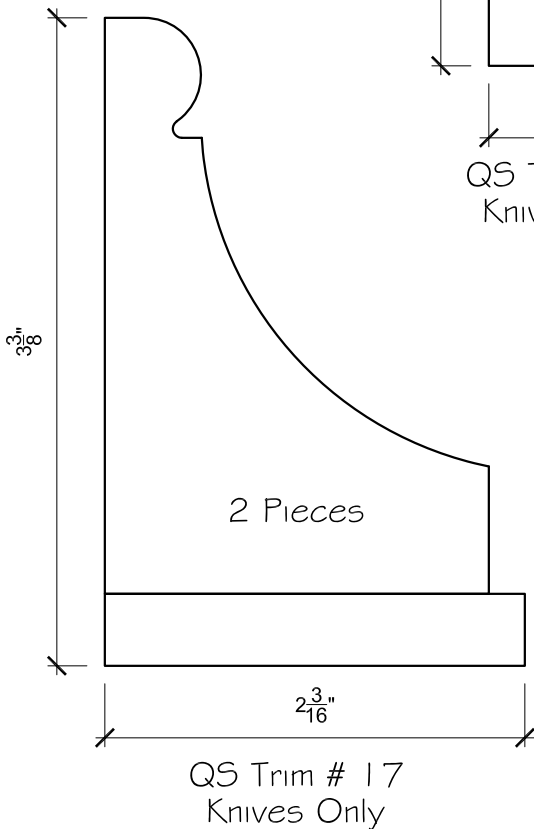
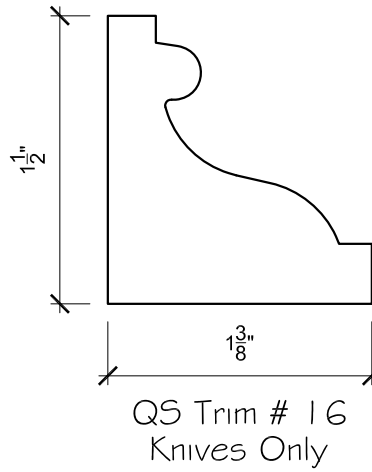
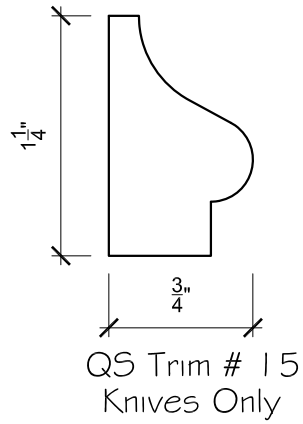
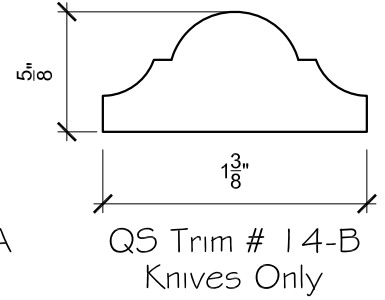
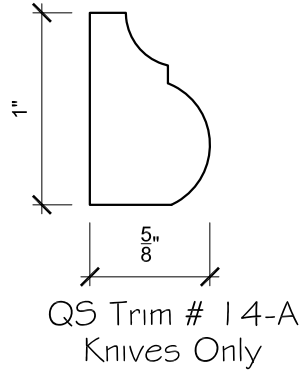
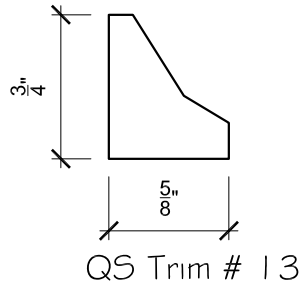
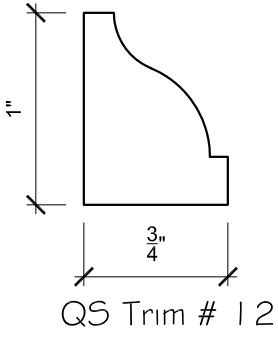

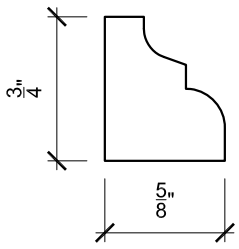

QS Trim # 20

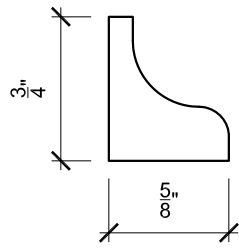

QS Trim # 21

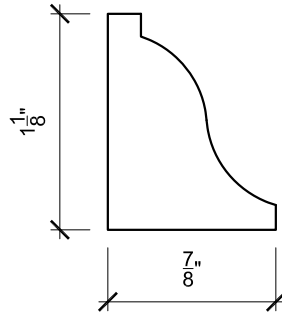

QS Trim # 22

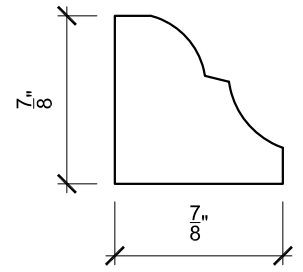

QS Trim # 23

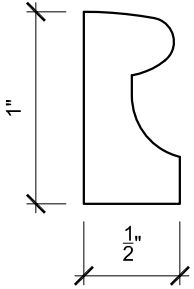

QS Trim # 24

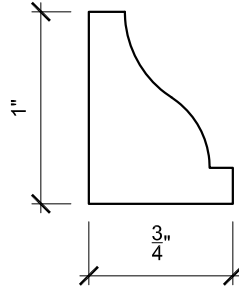

QS Trim # 25

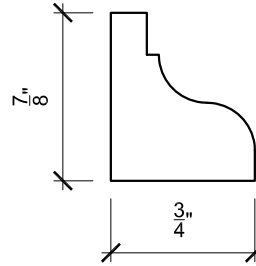

QS Trim # 26

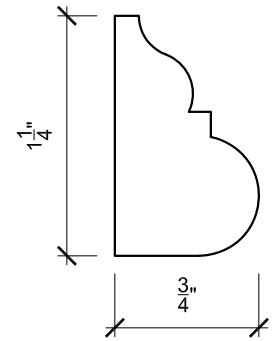

QS Trim # 27

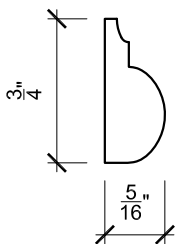

QS Trim # 28

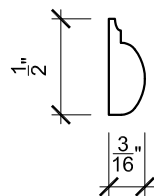

QS Trim # 29

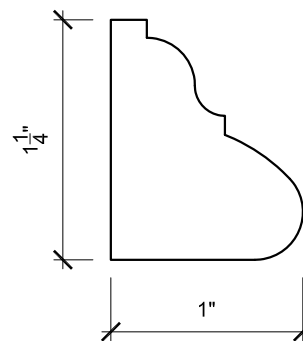

QS Trim # 30

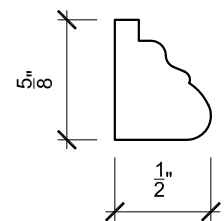

QS Trim # 31

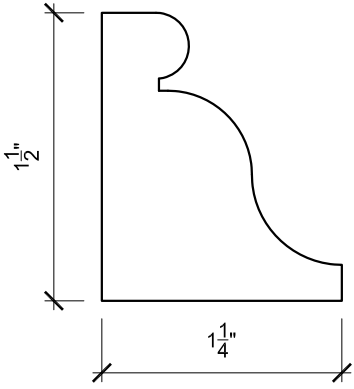

QS Trim # 32

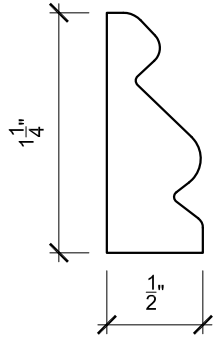

QS Trim # 33

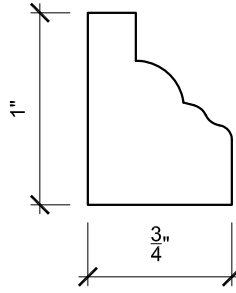

QS Trim # 34

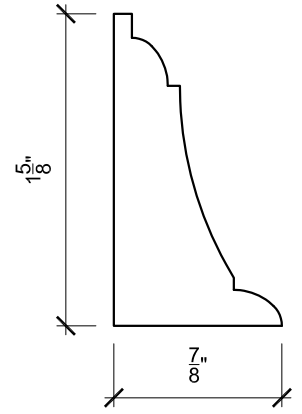

QS Trim # 35

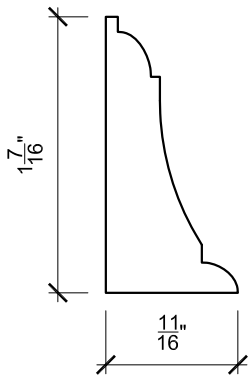

QS Trim # 36

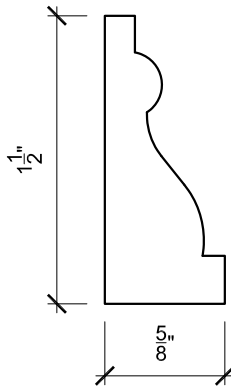

QS Trim # 37

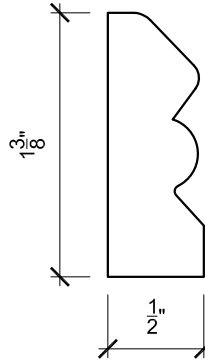

QS Trim # 38  
Router Bit

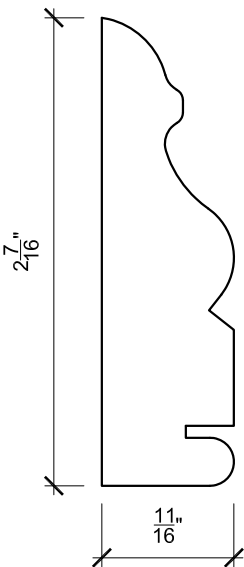

QS Trim # 39  
Knives Only

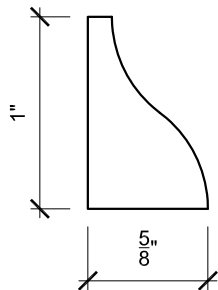

QS Trim # 40

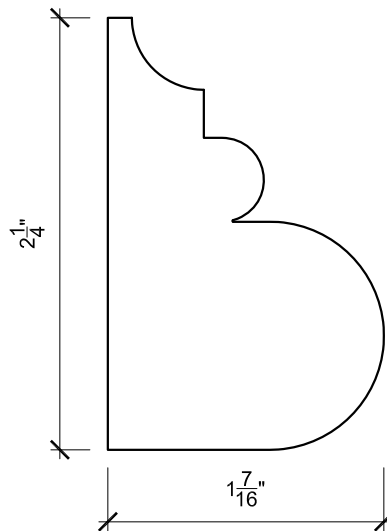

QS Trim # 41

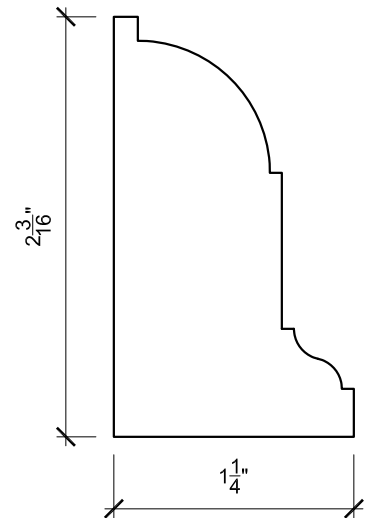

QS Trim # 42

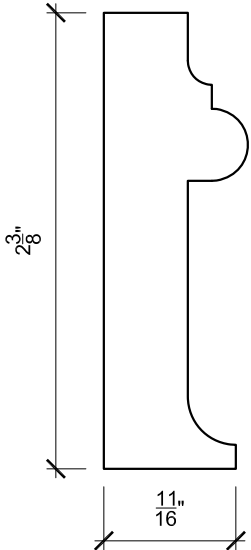

QS Trim # 43

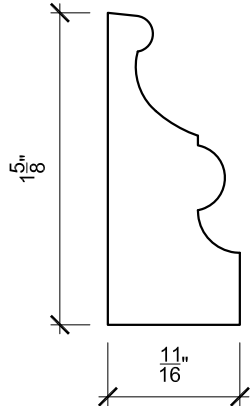

QS Trim # 44

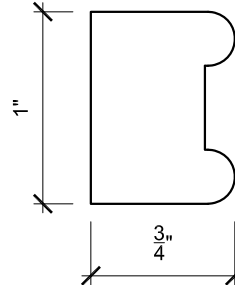

QS Trim # 45

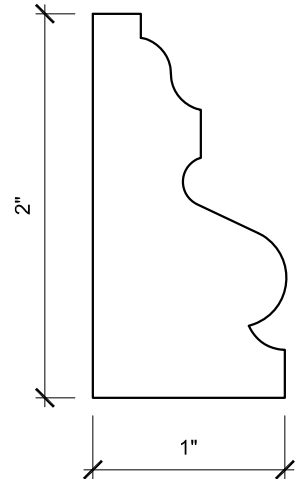

QS Trim # 46

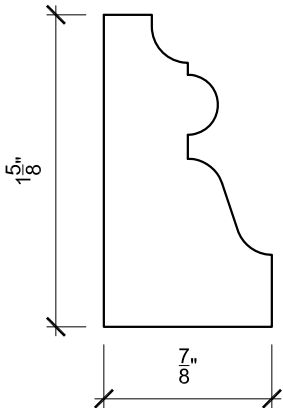

QS Trim # 47

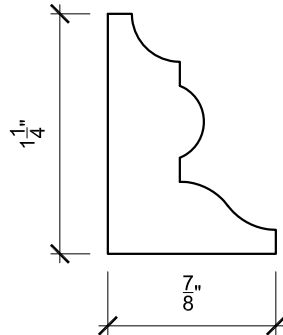

QS Trim # 48

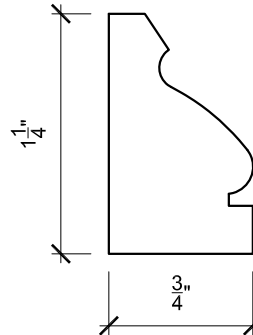

QS Trim # 49

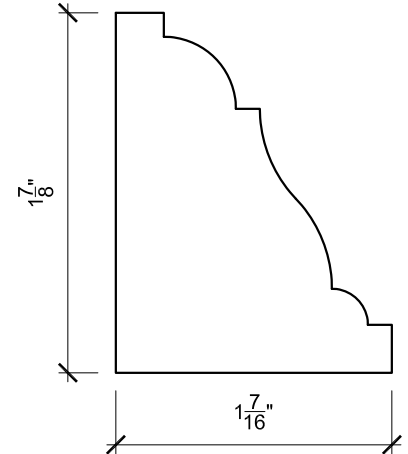

QS Trim # 50

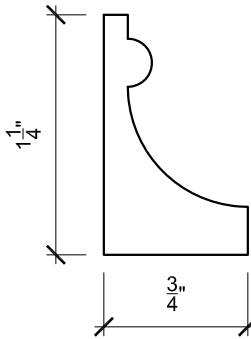

QS Trim # 51

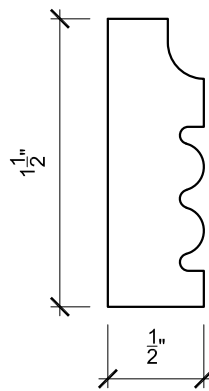

QS Trim # 52

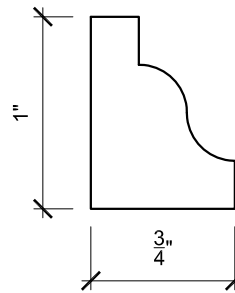

QS Trim # 53

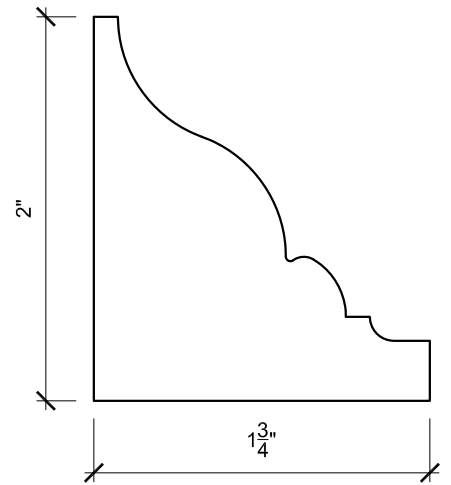

QS Trim # 54

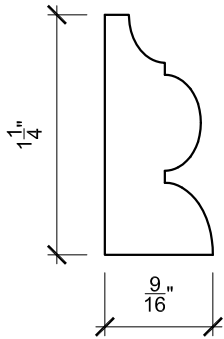

QS Trim # 55

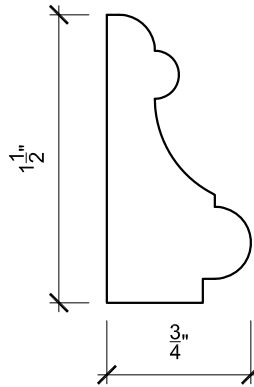

QS Trim # 56

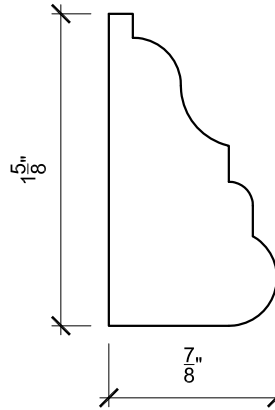

QS Trim # 57

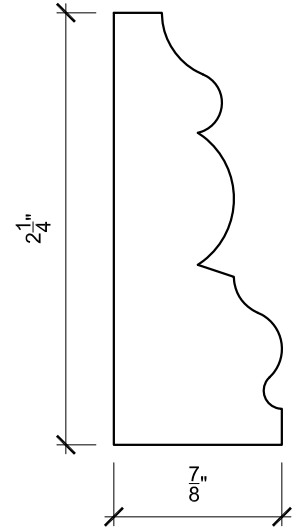

QS Trim # 58

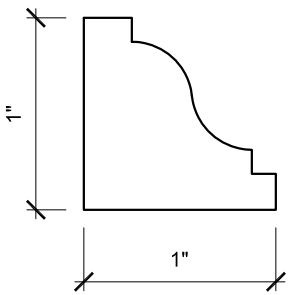

QS Trim # 59

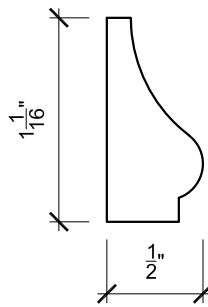

QS Trim # 60

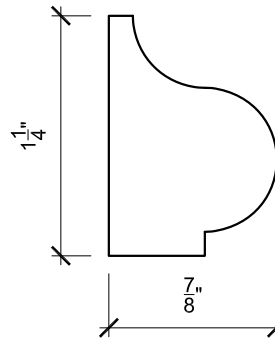

QS Trim # 61

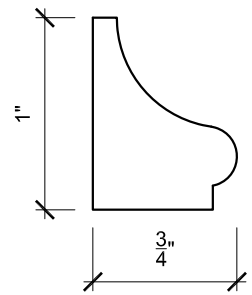

QS Trim # 62

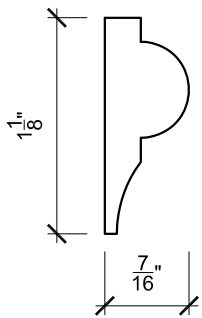

QS Trim # 63

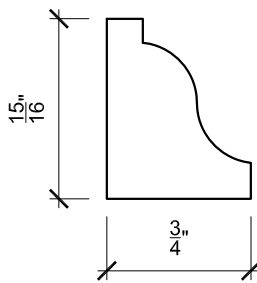

QS Trim # 64